

# Asycube 240

## Flexible Vibrating Feeder for Parts from 5 to 40 mm

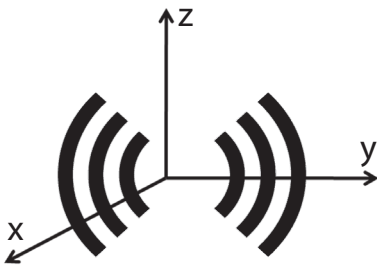
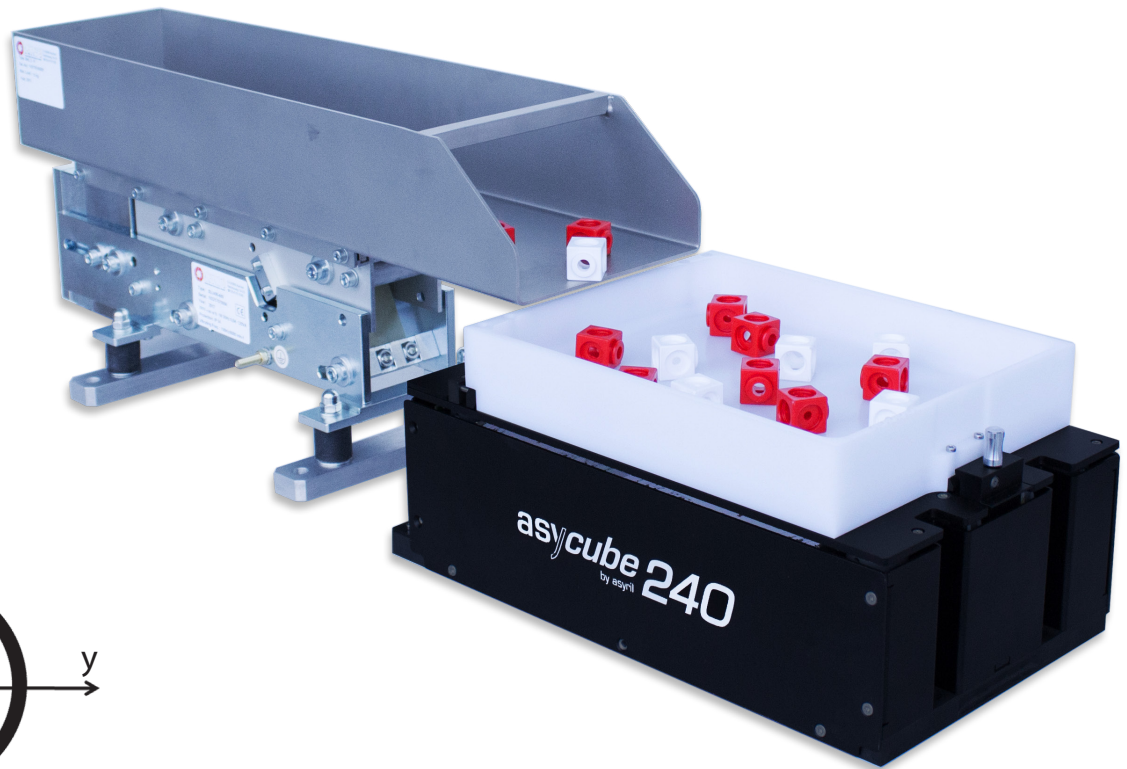

**3-Axis Vibration Technology**  
Innovation by **asyril**

### Feeder Advantages

- ▶ **Compatible with all part geometries** : 99% of parts can be fed on our feeders - including complex geometries and delicate materials
- ▶ **Extremely gentle part handling due to Asyril's innovative 3-axis vibration technology** : parts can be moved in all directions, including the optimal choice of flipping amplitude for each part. Minimal abrasion as parts do not need to be recirculated. Platform purge possible
- ▶ **Advanced reliability and durability** due to State-of-the-Art Voice Coil Technology ; no compressed air
- ▶ **Avoid backfeeding of vibration into surrounding machines** thanks to isolation of vibratory platform and feeder base
- ▶ **Precise part detection** thanks to integrated, adjustable backlight / optional SmartSight visual part detection system
- ▶ **Systematic part orientation** can be achieved with intelligently structured platforms (grooves, holes, nests, various materials)
- ▶ **Minimum production changeover times** enable flexible, future-proof production systems
- ▶ **Easy configuration** with Asyril's Feeder Control Center Software
- ▶ **Various hopper sizes**

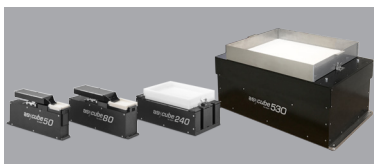

# Asycube 240

## Flexible Vibrating Feeder for Parts from 5 to 40 mm

### How it works

1. Homogeneous parts separation and orientation using Asyri's innovative 3-Axis Vibration Technology
2. Detection of correctly oriented parts by vision system (e.g. Asyri SmartSight)
3. Part pick from platform and assembly by robot

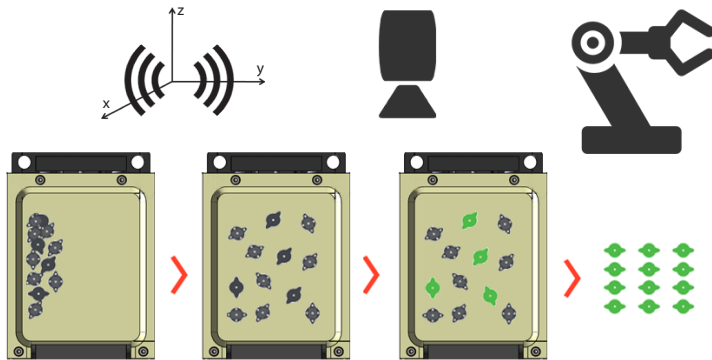

- Parts are spread homogeneously on the feeder surface and can even be systematically oriented in many cases by using intelligent vibration patterns in combination with a structured plate. Entire part families can thus be handled with a single feeder, making the system highly future-proof.

### Asyri's innovative 3-Axis Vibration Technology

- Systematic part orientation can be achieved with intelligently structured platforms (grooves, holes, nests).

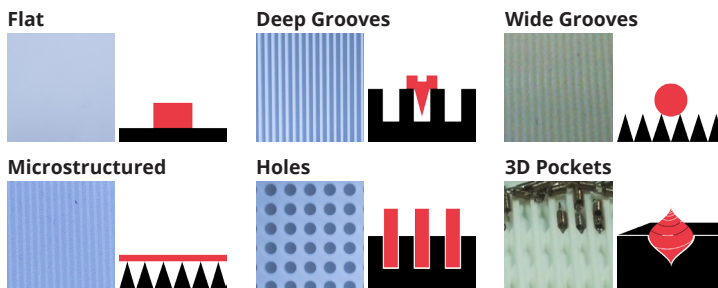

- Asyri's unique and patented 3-axis vibration technology allows moving parts freely on a platform in different directions.
- Using Asyri's intuitive HMI interface, the platform vibration parameters can be tuned specifically for an optimal part distribution and fastest resulting cycle time. A functioning part feeding recipe is typically created in less than 5 minutes

### About Asyri

- Asyri develops, produces and markets high performance flexible feeding systems for parts and components from <0.1 up to 150 mm in size. Our innovative 3-axis vibration technology can handle bulk parts of any geometry and allows for extremely gentle part feeding.
- Asyri's key competences and extensive know-how encompass all three sub-domains of modern part feeding systems: vibration technology, industrial vision and precision robotics. This unique focus combined with our many years of experience enable us to deliver superior, innovative flexible feeding systems for today's and tomorrow automation challenges.

### Specifications

#### GENERAL INFORMATION

<b>Communication</b>	Ethernet (TCP/IP), Modbus TCP
Optional via Gateway	EtherNet/IP, EtherCAT, PROFIBUS, SERCOS
<b>Power supply</b>	24 V / 8 A
<b>Backlight synchronization input</b>	
<b>Libraries / Software plugins</b>	FANUC .NET DENSO STÄUBLI

#### OPTIONS

<b>Visual part detection system</b>	Asyri SmartSight
<b>Integrated LED backlight</b>	red / green / blue / white / infrared
<b>Vibration plate</b>	flat / holes / grooves / nests / various materials
<b>Purge platform</b>	
<b>Calibration plate</b>	
<b>Connection cables</b>	power / communication / backlight
<b>Various hopper sizes</b>	2 liters 3 liters
<b>Custom platform material</b>	on demand (e.g. medical)

#### DIMENSIONS

Description	Reference	Dimensions	
		[mm]	[-inches]
<b>Typical part size</b>		5 -40	~ 0.2 - 1.5
<b>Vibration platform</b>	A	150	~ 5.9
	B	195	~ 7.6
<b>Footprint</b>	C	171	~ 6.7
	D	300	~ 11.8
	D'	55	~ 2.2
<b>Maximum height</b>	E	132	~ 5.2
<b>Pick height</b>	F	105	~ 4.1

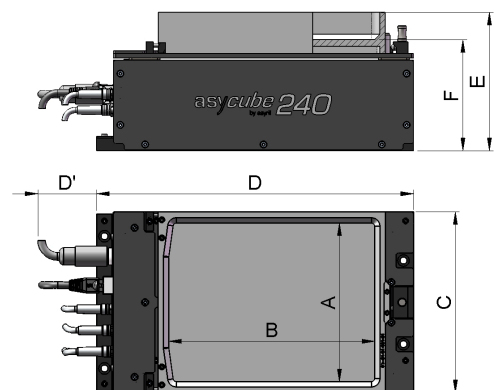

### Contact

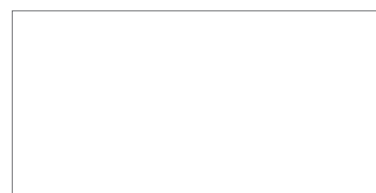

**Asyri SA**  
Z.I. du Vivier 22  
CH-1690 Villaz-St-Pierre  
SWITZERLAND

scan to see the videos  
[www.asyri.com](http://www.asyri.com)  
sales@asyri.com  
Tel +41(0) 26 653 71 90  
[youtube.com/AsyriSA](http://youtube.com/AsyriSA)